



# TDA7297SA

## 10W+10W DUAL BRIDGE AMPLIFIER

- WIDE SUPPLY VOLTAGE RANGE (6V-18V)
- MINIMUM EXTERNAL COMPONENTS
  - NO SWR CAPACITOR
  - NO BOOTSTRAP
  - NO BOUCHEROT CELLS
  - INTERNALLY FIXED GAIN
- STAND-BY & MUTE FUNCTIONS
- SHORT CIRCUIT PROTECTION
- THERMAL OVERLOAD PROTECTION

TECHNOLOGY B120II

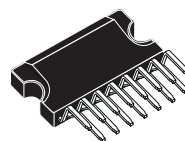

CLIPWATT15  
ORDERING NUMBER: TDA7297SA

### DESCRIPTION

The TDA7297SA is a dual bridge amplifier specially designed for TV and Portable Radio applications.

Pin to pin compatible with: TDA7297, TDA7266B, TDA7266SA, TDA7266M, TDA7266MA, TDA7266, & TDA7266S.

### BLOCK AND APPLICATION DIAGRAM

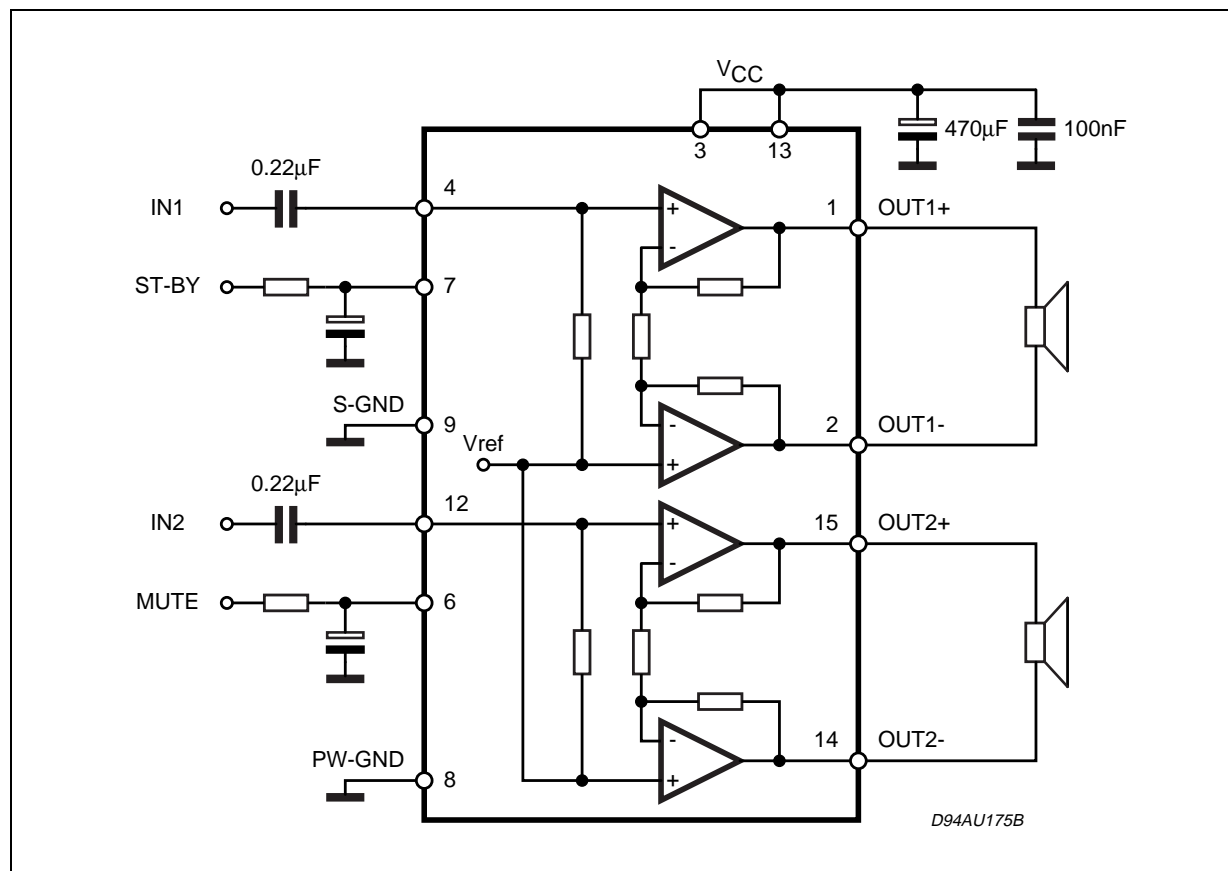

# TDA7297SA

## ABSOLUTE MAXIMUM RATINGS

Symbol	Parameter	Value	Unit
$V_s$	Supply Voltage	20	V
$I_O$	Output Peak Current (internally limited)	2	A
$P_{tot}$	Total power dissipation ( $T_{case} = 70^\circ C$ )	30	W
$T_{op}$	Operating Temperature	0 to 70	$^\circ C$
$T_{stg}, T_j$	Storage and Junction Temperature	-40 to 150	$^\circ C$

## THERMAL DATA

Symbol	Parameter	Value	Unit
$R_{th\ j-case}$	Thermal Resistance Junction-case	Typ. = 1.8; Max. = 2.5	$^\circ C/W$
$R_{th\ j-amb}$	Thermal Resistance Junction to ambient	48	$^\circ C/W$

## PIN CONNECTION (Top view)

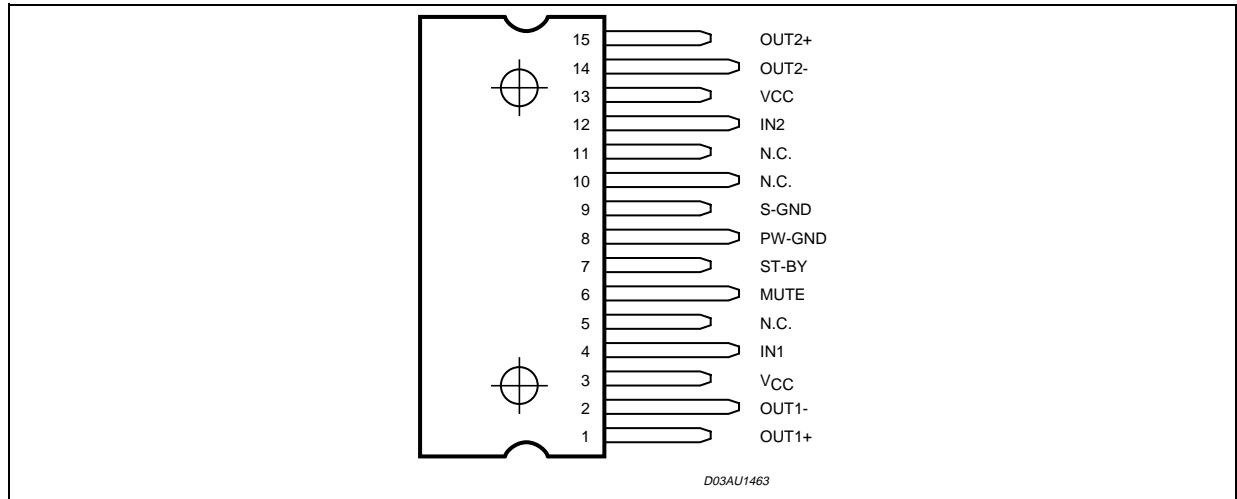

## ELECTRICAL CHARACTERISTICS

( $V_{CC} = 13V$ ,  $R_L = 8\Omega$ ,  $f = 1KHz$ ,  $T_{amb} = 25^\circ C$  unless otherwise specified)

Symbol	Parameter	Test Condition	Min.	Typ.	Max.	Unit
$V_{CC}$	Supply Range		6.5		18	V
$I_q$	Total Quiescent Current	$R_L = \infty$		50	65	mA
$V_{OS}$	Output Offset Voltage				120	mV
$P_O$	Output Power	THD 10%	8.3	10		W
THD	Total Harmonic Distortion	$P_O = 1W$		0.1	0.3	%
		$P_O = 0.1W$ to $2W$ $f = 100Hz$ to $15KHz$			1	%
SVR	Supply Voltage Rejection	$f = 100Hz$ , $V_R = 0.5V$	40	56		dB
CT	Crosstalk		46	60		dB
$A_{MUTE}$	Mute Attenuation		60	80		dB
$T_w$	Thermal Threshold			150		$^\circ C$
$G_V$	Closed Loop Voltage Gain		31	32	33	dB
$\Delta G_V$	Voltage Gain Matching				0.5	dB

**ELECTRICAL CHARACTERISTICS** (continued)(V<sub>CC</sub> = 13V, R<sub>L</sub> = 8Ω, f = 1KHz, T<sub>amb</sub> = 25°C unless otherwise specified)

Symbol	Parameter	Test Condition	Min.	Typ.	Max.	Unit
R <sub>i</sub>	Input Resistance		25	30		KΩ
V <sub>T MUTE</sub>	Mute Threshold	V <sub>o</sub> = -30dB	2.3	2.9	4.1	V
V <sub>T ST-BY</sub>	St-by Threshold		0.8	1.3	1.8	V
I <sub>ST-BY</sub>	St-by Current V <sub>6</sub> = GND				100	μA
e <sub>N</sub>	Total Output Voltage	A Curve; f = 20Hz to 20KHz		150 220	500	μV μV

**APPLICATION SUGGESTION****STAND-BY AND MUTE FUNCTIONS****(A) Microprocessor Application**

In order to avoid annoying "Pop-Noise" during Turn-On/Off transients, it is necessary to guarantee the right St-by and mute signals sequence. It is quite simple to obtain this function using a microprocessor (Fig. 1 and 2). At first St-by signal (from μP) goes high and the voltage across the St-by terminal (Pin 7) starts to increase exponentially. The external RC network is intended to turn-on slowly the biasing circuits of the amplifier, this to avoid "POP" and "CLICK" on the outputs.

When this voltage reaches the St-by threshold level, the amplifier is switched-on and the external capacitors in series to the input terminals (C3, C5) start to charge.

It's necessary to maintain the mute signal low until the capacitors are fully charged, this to avoid that the device goes in play mode causing a loud "Pop Noise" on the speakers.

A delay of 100-200ms between St-by and mute signals is suitable for a proper operation.

**Figure 1. Microprocessor Application**

Figure 2. Microprocessor Driving Signals



**B) Low Cost Application**

In low cost applications where the  $\mu P$  is not present, the suggested circuit is shown in fig.3.

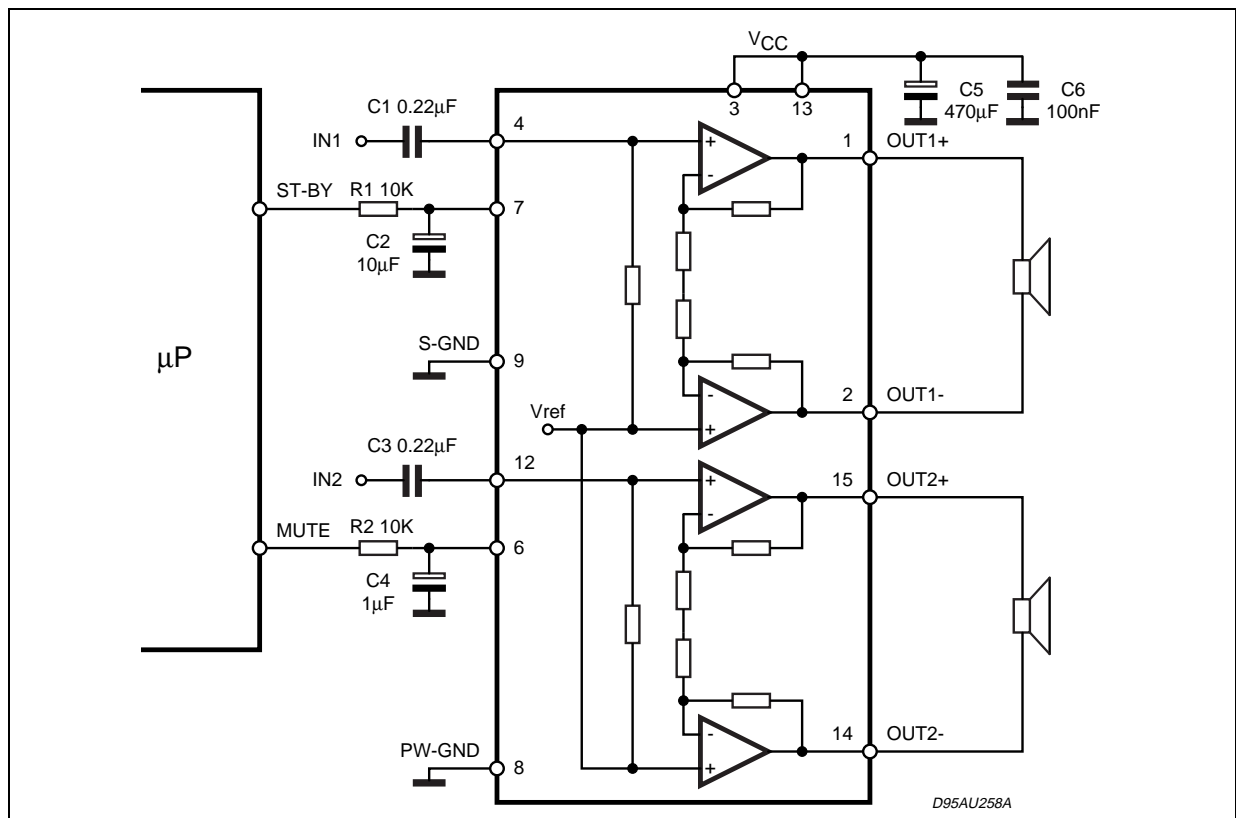
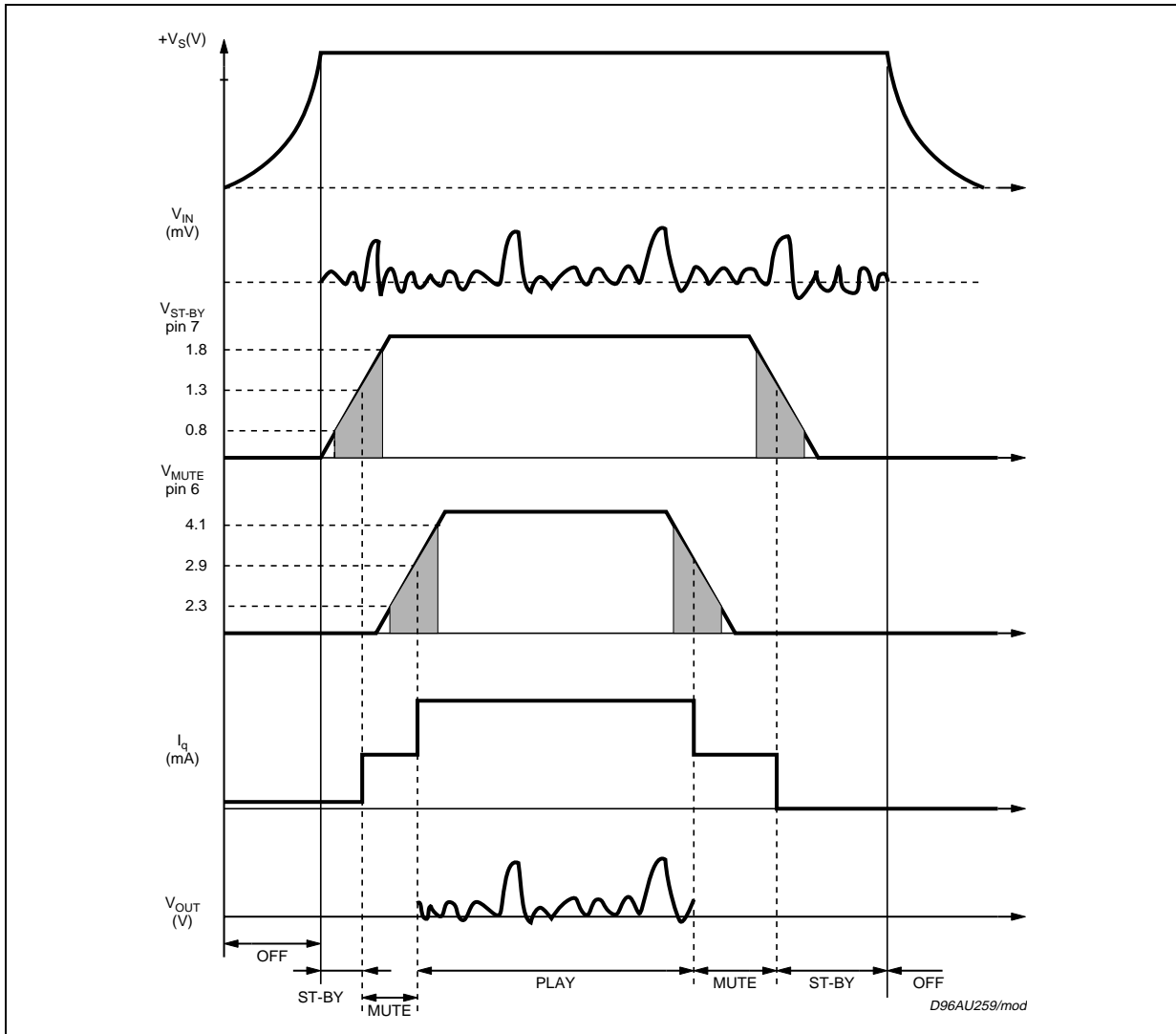
The St-by and mute terminals are tied together and they are connected to the supply line via an external voltage divider.

The device is switched-on/off from the supply line and the external capacitor C4 is intended to delay the St-by and mute threshold exceeding, avoiding "Popping" problems.

Figure 3. Stand-alone low-cost Application

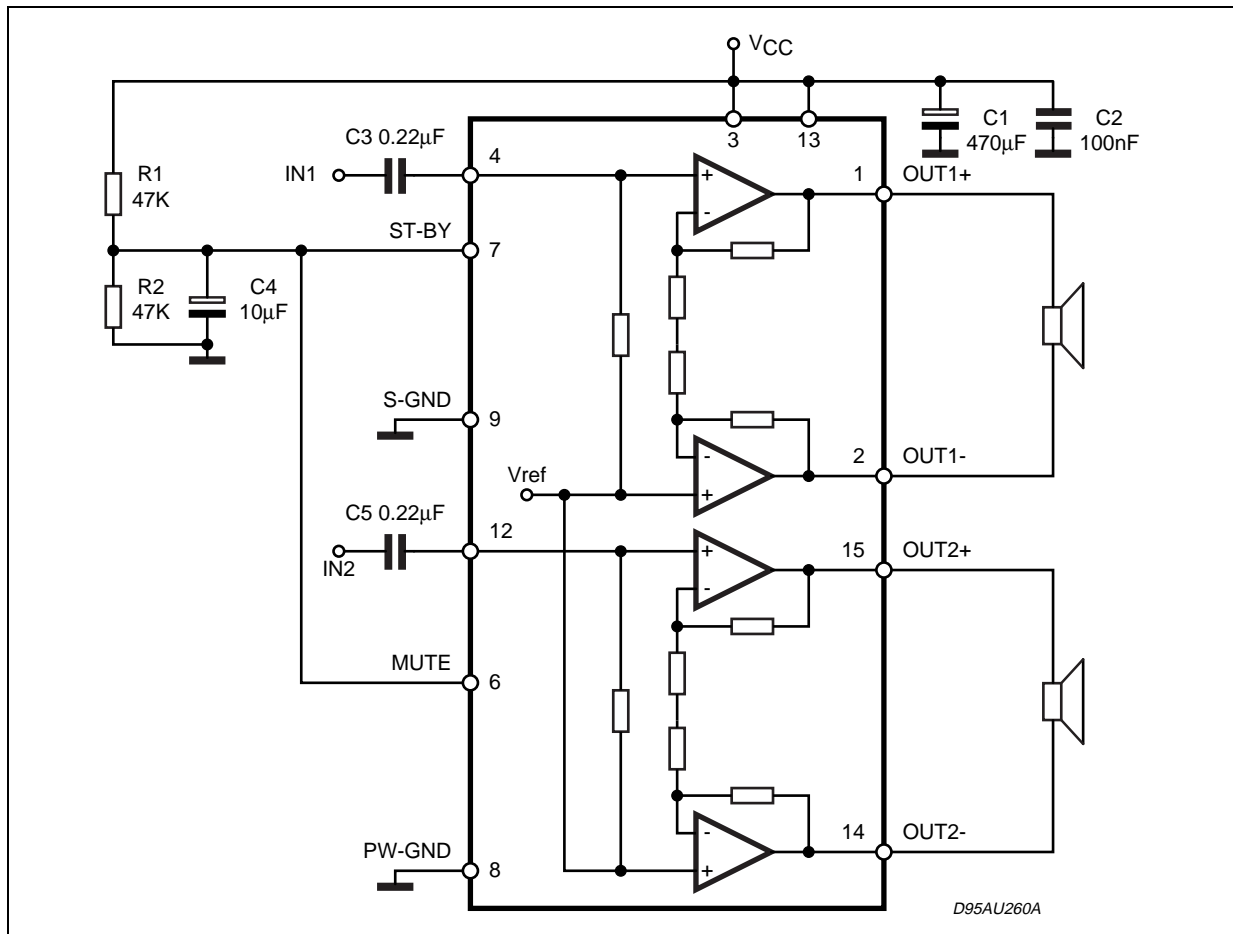

Figure 4. Distortion vs Output Power.

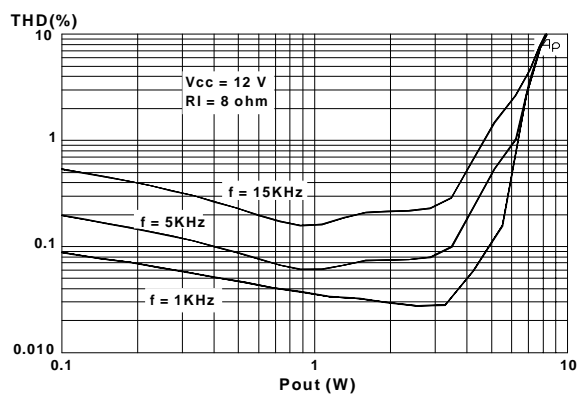

Figure 5. Distortion vs Frequency

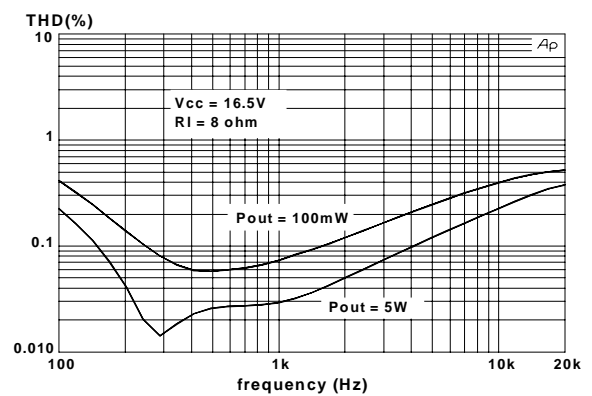

Figure 6. Frequency Response

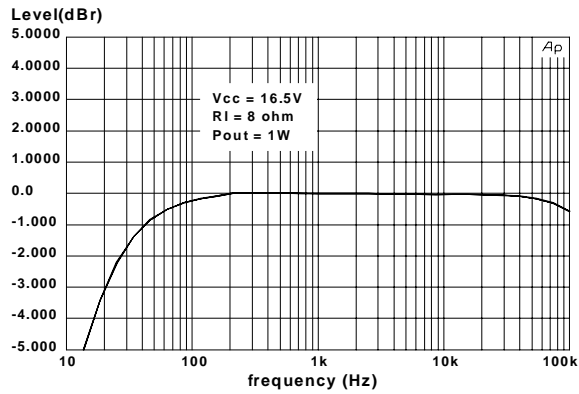

Figure 9. Mute Attenuation vs Vpin 6

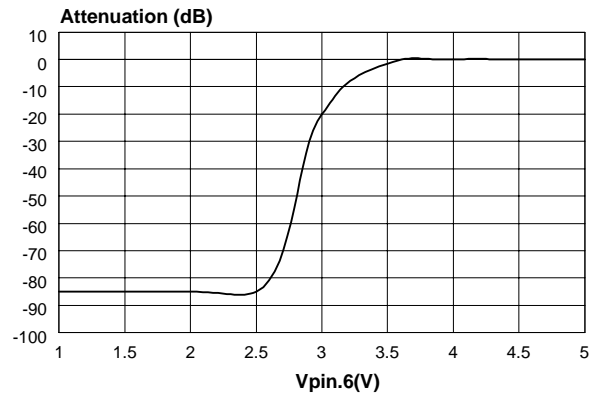

Figure 7. Output Power vs Supply Voltage

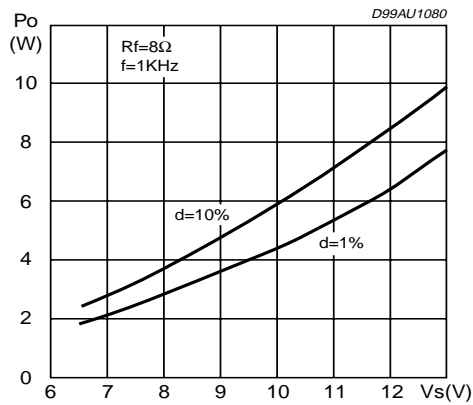

Figure 10. Stand-By attenuation vs Vpin 7

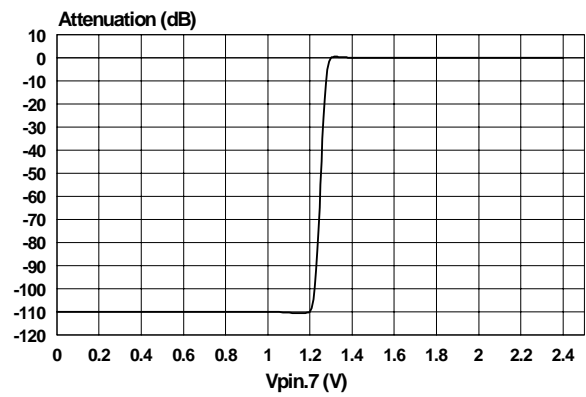

Figure 8. Ptot & Efficiency vs Output Power

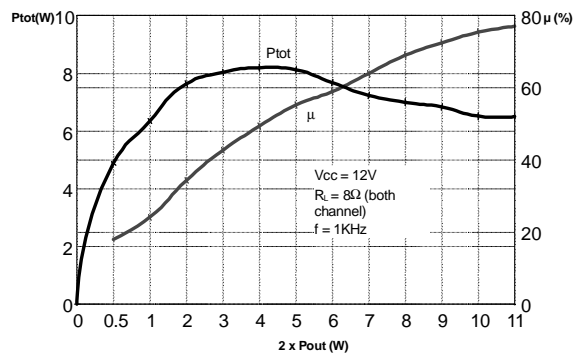

Figure 11. Quiescent Current vs Supply Voltage

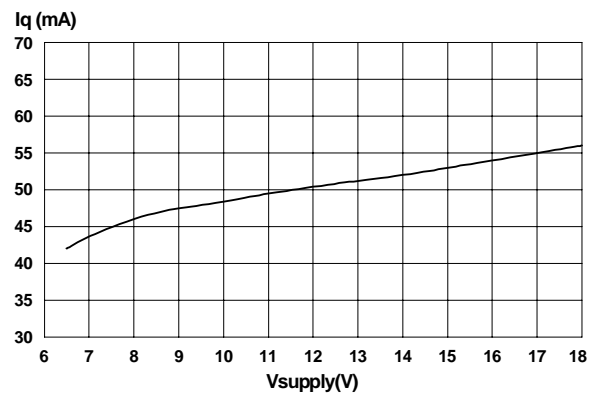

Figure 12. PC Board Component Layout

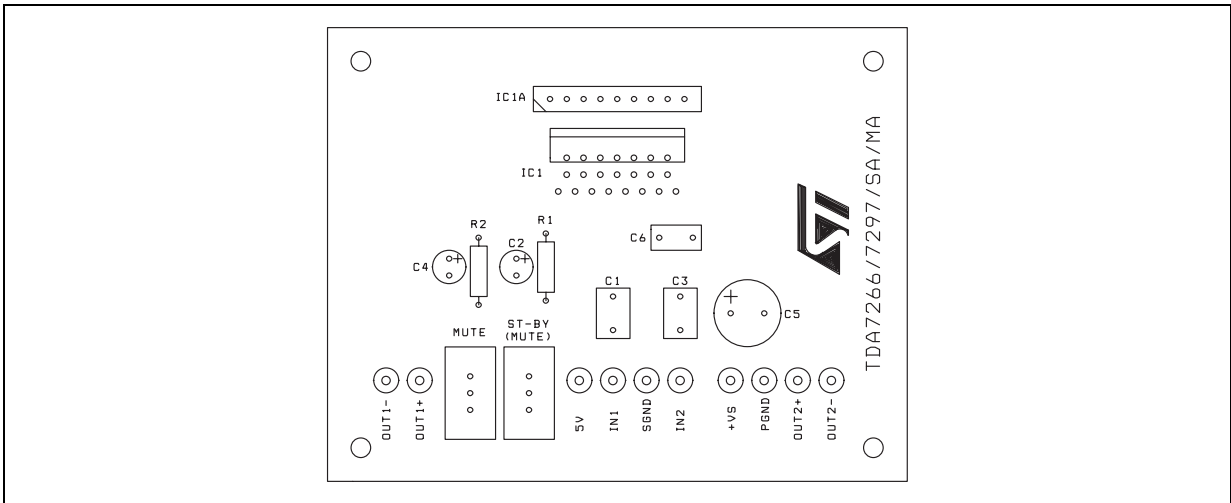

Figure 13. Evaluation Board Top Layer Layout

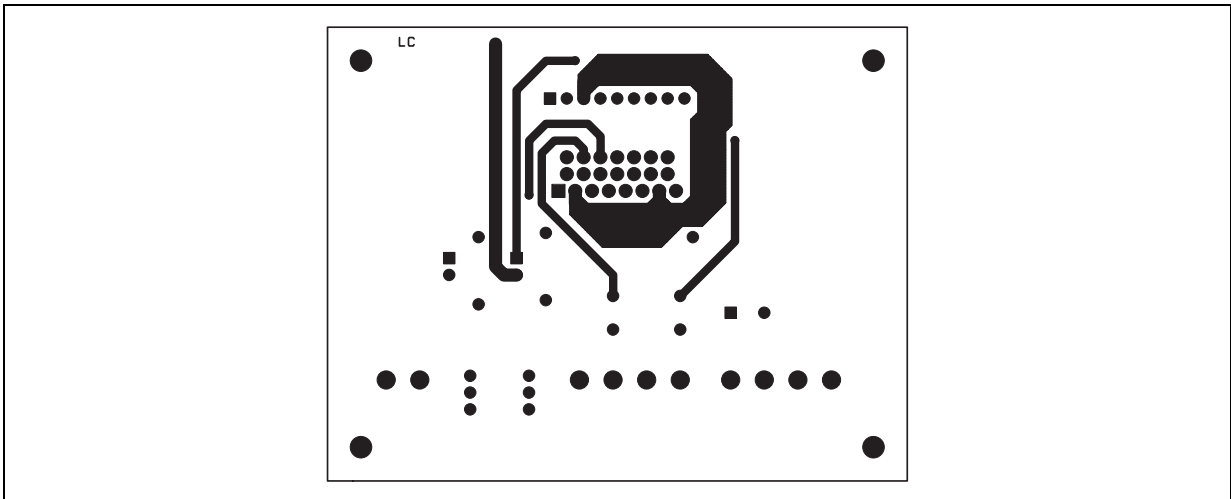
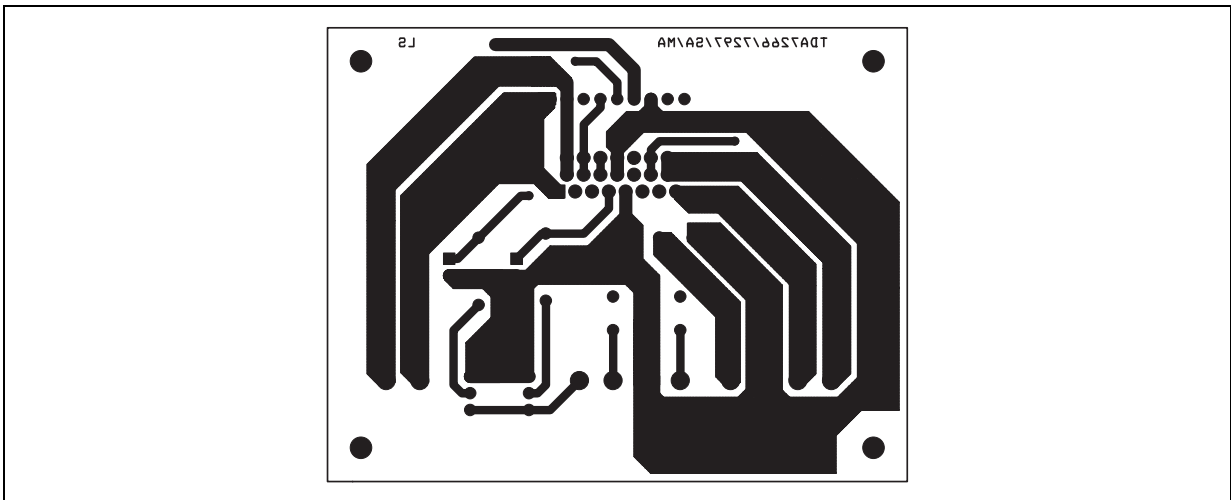

Figure 14. Evaluation Board Bottom Layer Layout



**HEAT SINK DIMENSIONING:**

In order to avoid the thermal protection intervention, that is placed approximatively at  $T_j = 150^{\circ}\text{C}$ , it is important the dimensioning of the Heat Sink  $R_{Th}$  ( $^{\circ}\text{C}/\text{W}$ ).

The parameters that influence the dimensioning are:

- Maximum dissipated power for the device ( $P_{dmax}$ )
- Max thermal resistance Junction to case ( $R_{Th\ j-c}$ )
- Max. ambient temperature  $T_{amb\ max}$
- Quiescent current  $I_q$  (mA)

Example:

$V_{CC} = 13\text{V}$ ,  $R_{load} = 80\text{ohm}$ ,  $R_{Th\ j-c} = 2.5\ ^{\circ}\text{C}/\text{W}$ ,  $T_{amb\ max} = 50^{\circ}\text{C}$

$$P_{dmax} = (N^{\circ}\ \text{channels}) \cdot \frac{V_{cc}^2}{\Pi^2 \cdot \frac{R_{load}}{2}} + I_q \cdot V_{cc}$$

$$P_{dmax} = 2 \cdot (4.28) + 0.5 = 9\ \text{W}$$

$$(\text{Heat Sink})\ R_{Th\ c-a} = \frac{150 - T_{amb\ max}}{P_{d\ max}} - R_{Th\ j-c} = \frac{150 - 50}{9} - 2.5 = 8.6^{\circ}\text{C}/\text{W}$$

In figure 15 is shown the Power derating curve for the device.

**Figure 15. Power derating curve**

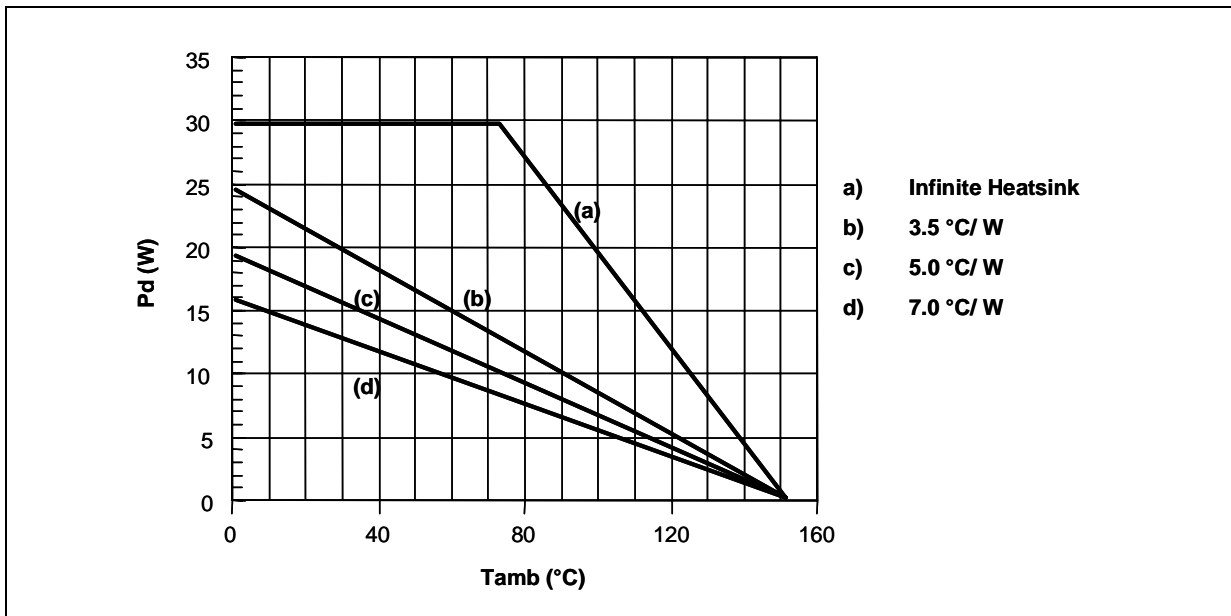



### Clipwatt Assembling Suggestions

The suggested mounting method of Clipwatt on external heat sink, requires the use of a clip placed as much as possible in the plastic body center, as indicated in the example of figure 16.

A thermal grease can be used in order to reduce the additional thermal resistance of the contact between package and heatsink.

A pressing force of 7 - 10 Kg gives a good contact and the clip must be designed in order to avoid a maximum contact pressure of 15 Kg/mm<sup>2</sup> between it and the plastic body case.

As example, if a 15Kg force is applied by the clip on the package, the clip must have a contact area of 1mm<sup>2</sup> at least.

**Figure 16. Example of right placement of the clip**

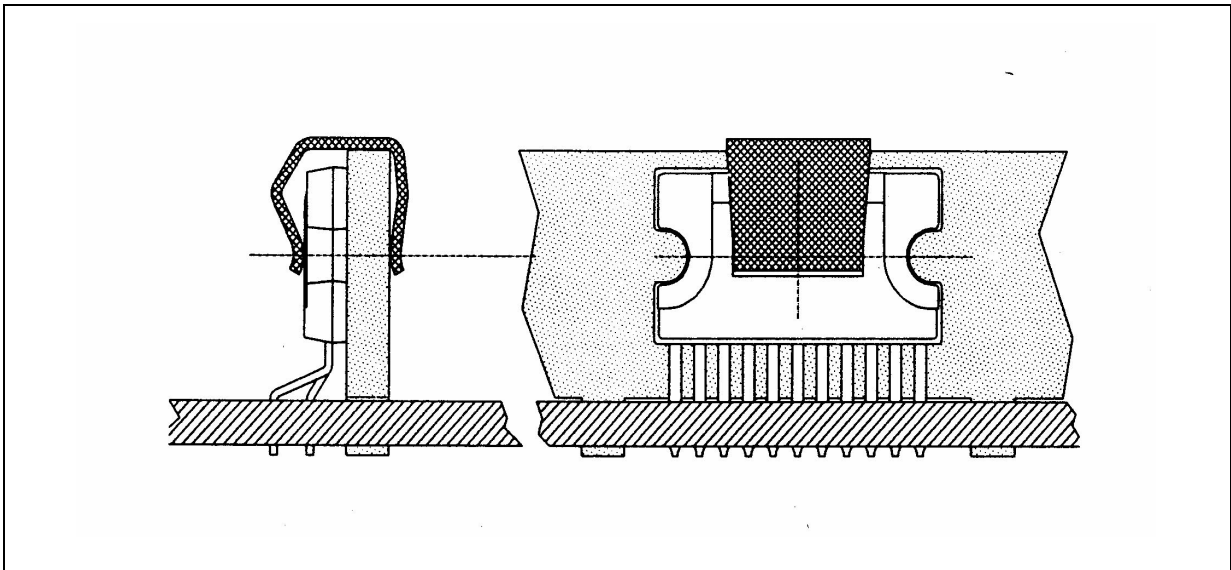

DIM.	mm			inch		
	MIN.	TYP.	MAX.	MIN.	TYP.	MAX.
A			3.2			0.126
B			1.05			0.041
C		0.15			0.006	
D		1.55			0.061	
E	0.49		0.55	0.019		0.022
F	0.67		0.73	0.026		0.029
G	1.14	1.27	1.4	0.045	0.050	0.055
G1	17.57	17.78	17.91	0.692	0.700	0.705
H1		12			0.480	
H2		18.6			0.732	
H3	19.85			0.781		
L		17.95			0.707	
L1		14.45			0.569	
L2	10.7	11	11.2	0.421	0.433	0.441
L3		5.5			0.217	
M		2.54			0.100	
M1		2.54			0.100	

**OUTLINE AND MECHANICAL DATA**

Weight: 1.92gr

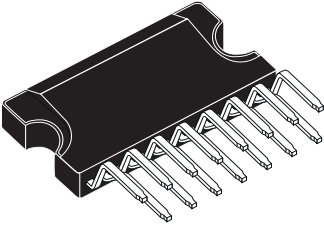

**Clipwatt15**

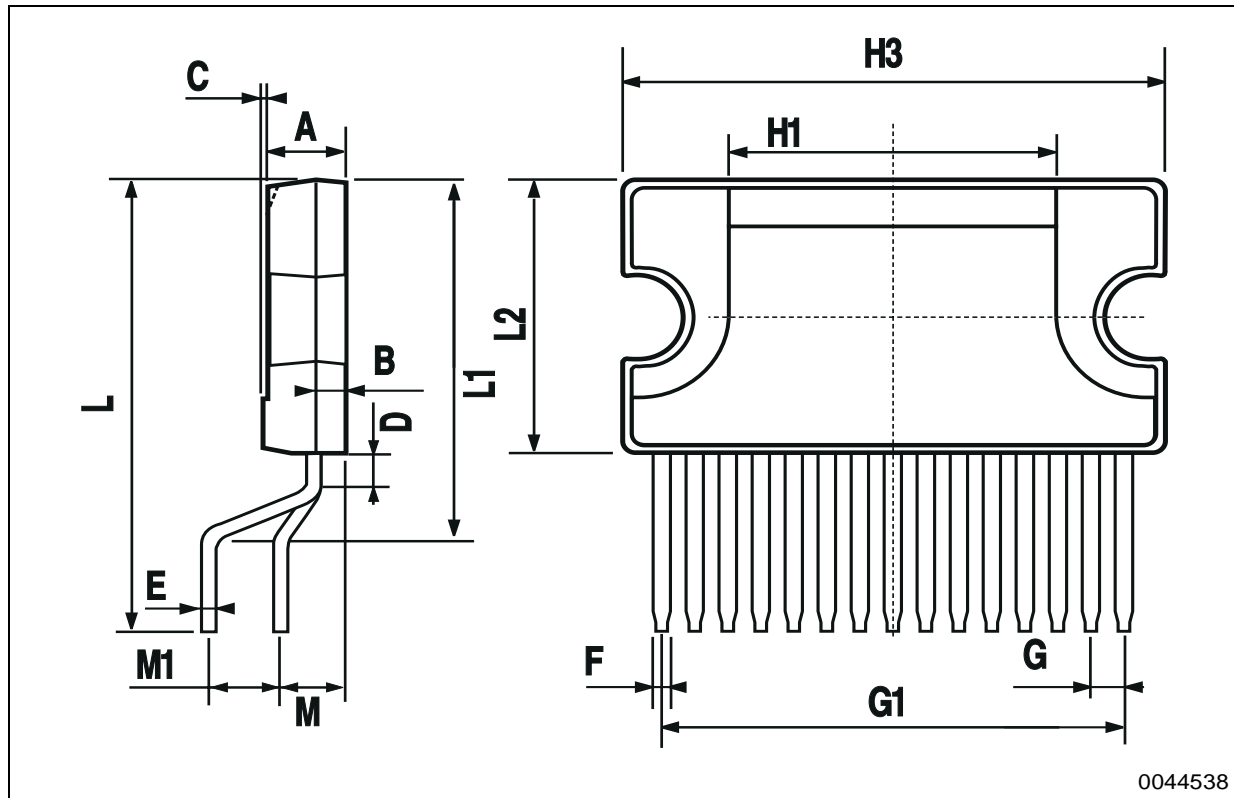

Information furnished is believed to be accurate and reliable. However, STMicroelectronics assumes no responsibility for the consequences of use of such information nor for any infringement of patents or other rights of third parties which may result from its use. No license is granted by implication or otherwise under any patent or patent rights of STMicroelectronics. Specifications mentioned in this publication are subject to change without notice. This publication supersedes and replaces all information previously supplied. STMicroelectronics products are not authorized for use as critical components in life support devices or systems without express written approval of STMicroelectronics.

The ST logo is a registered trademark of STMicroelectronics.  
All other names are the property of their respective owners

© 2003 STMicroelectronics - All rights reserved

**STMicroelectronics GROUP OF COMPANIES**

Australia - Belgium - Brazil - Canada - China - Czech Republic - Finland - France - Germany - Hong Kong - India - Israel - Italy - Japan -  
Malaysia - Malta - Morocco - Singapore - Spain - Sweden - Switzerland - United Kingdom - United States

[www.st.com](http://www.st.com)

